

AC1000 AMPLIFIER & OPTICAL NODE PLATFORM



The AC1000 is a single active output amplifier with 29 dB or 39 dB of platforms. Both platforms can be used normally as an amplifier, but also as an optical node. The input and output amplifier stages are both based on high performance solutions, that makes the used gain range especially wide. The amplifier can be used in distribution purposes in high gain mode but also as a line amplifier with lower gain. By using internal splitting there are 3 separate outputs available.

The amplifier is very flexible and scaleable. It does the basic amplifier functions but can be modified with passive or active plug-in modules to carry out more sophisticated solutions like a two-way optical node. The required modules can be ordered as factory installed with the amplifier, but it is also possible to update the amplifier later in the field.

All essential return path elements like ingress switches are fixed built on the mother board but for example return amplifier module can be chosen after the needed performance.

Features

- US ingress monitoring option
- Improved US noise figure
- All amplifiers stages use GaAs technology
- 1...3 output by internal splitting
- Can be ordered or updated later to an optical node
- Improved ESD and surge protection
- HMS compatible transponder module available
- Fixed station memory for electrical identification
- Electrical gain & slope control modules
- Optional spectrum analyser function

Technical specifications (amplifier)

Parameter	Specification	Note
Downstream signal path (values with diplex filters)		
Frequency range	47 / 54 / 70 / 85...862 MHz	
Return loss	20 dB	1
Gain (29 / 39 dB platform)	23...29 / 29...39 dB	2
Input attenuator control range	20 dB	
Input equaliser control range	25 dB	3
Mid-stage slope	8 dB	4
Flatness	± 0.4 dB	5
Group delay	2 ns	6
Test point	- 20 dB	7
Transponder connection	- 19 dB	8
Input by-pass attenuation	- 2 dB	
Noise figure (29 / 39 dB platform)	6.5 / 5.5 dB	9
Output level, DIN 45004B	127.5 dB μ V	10
CTB 42 channels	113.0 dB μ V	11
CSO 42 channels	117.0 dB μ V	11
XMOD 42 channels	112.0 dB μ V	11
CTB 110 / 77 channels	71.0 / 79.0 dBc	12
CSO 110 / 77 channels	66.0 / 74.0 dBc	12
XMOD 110 / 77 channels	66.0 / 73.0 dBc	12
Upstream signal path (values with diplex filters)		
Frequency range	5...30 / 42 / 50 / 65 MHz	
Return loss	18 dB	13
Gain	21 / - 6.0 dB	14
Ingress switching	0 / - 6 / < - 50 dB	
Gain control range	20 dB	15
Equaliser control range	7 dB	16
Flatness	± 0.5 dB	17
Test signal injection point	- 30 dB	18
Transponder connection	- 26 dB	19
Noise figure	7.5 dB	20
Output level, DIN 45004B	113.0 dB μ V	20
General		
Power consumption (29 / 39 dB platform)	15 / 19 W	21
Supply voltage	27...65 Vac , ±33...90Vdc / 205...255 Vac	
Supply current	see note	22
Maximum current feed through	8.0 A / port	23
Hum modulation	70 dB	23
Resistance for remote current	25 m Ω / port	
Input / Output connectors	PG11	
Test point connectors	F- female	
Dimensions	245 x 255 x 100 mm	h x w x d
Weight	3.0 kg	
Operating temperature	-40...+55 °C	
Class of enclosure	IP67	24
EMC	EN50083-2	
ESD	4 kV	25
Surge	6 kV	26

Technical specifications (optical node)

Parameter	Specification	Note
The following specifications are valid for AC1000 when used as an optical node. If parameter is not specified in this section, the relevant corresponding parameter from amplifier part above can be used.		
Downstream signal path (values with diplex filter)		
Light wavelength	1290...1600 nm	27
Optical input power range	- 7...+ 2dBm	28
Gain limited output level (29/39 dB platform)	100 / 109 dBuV	29
Flatness	± 0.5 dB	30
Noise current density	7 pA / √ Hz	31
Upstream signal path (values with diplex filter)		
Input level	61.0 dBμV	32
General		
Power consumption (29 / 39 dB platform)	21 / 25 W	33
Supply current	see note	34
Class of enclosure	IP54	35

Notes

- 1) The limiting curve is defined at 40 MHz -1.5 dB / octave.
- 2) Guaranteed maximum gain is 38.0 dB for platform of higher gain and 29.0 dB for platform of lower gain. With mid-stage gain control possibility the amplifier can be used in low gain mode. Gain is defined with mid-stage equaliser and 2 pcs of diplex filters. All other used plug modules are 0 db jumpers.

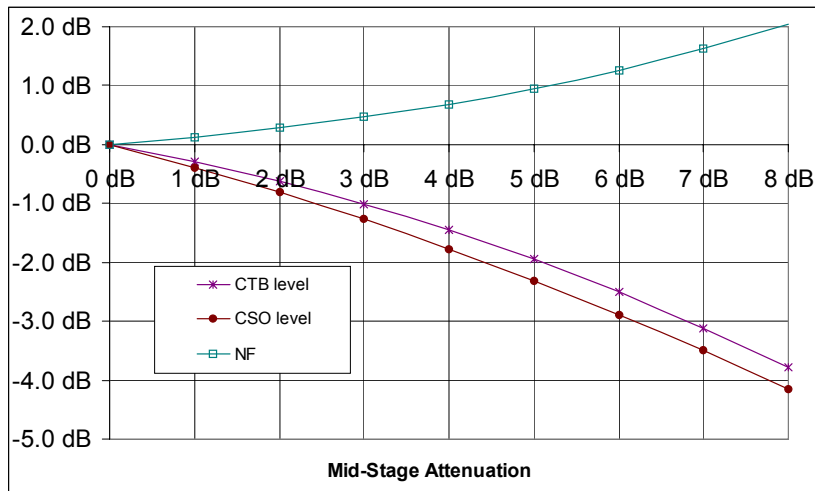
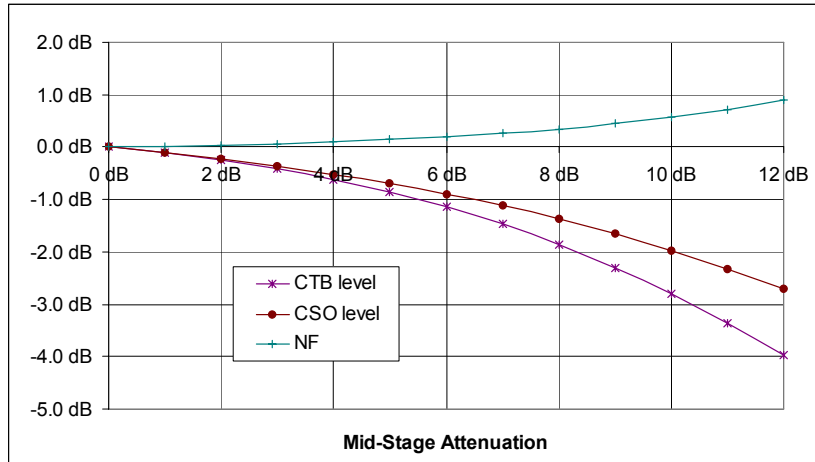

The pictures are showing how the NF and distortion performances are changing if mid-stage gain control is used. Higher picture is valid for 39 dB version and lower picture is valid for 29 dB version. Defined with the 8 dB sloped output and CENELEC loading. NF curve is defined at 862 MHz.

- 3) Fixed value attenuators and equalisers are available.
- 4) The amplifier is defined with 8 dB tilted output. However, it is possible to use the amplifier with other slopes by changing the mid-stage equaliser plug.
- 5) Typical value. The guaranteed value is ± 0.75 dB. Flatness is defined with mid-stage equaliser and 2 pcs of diplex filters. All other used plug modules are 0 dB jumpers. Spec is valid 2 MHz after the starting frequency of the selected diplex filter.
- 6) Typical value for 4.43 MHz band. Measured at channel S2. At higher frequencies the specification is better.
- 7) Output TP is from a directional coupler and has a ± 0.75 dB tolerance. The TP is defined with 0 dB plug as OUTPUT MODULE 1. This connection can be used also as an injection point for a test signal of return channel. Input TP is a transformer type and it is having an accuracy of ± 1.5 . It can be used as the output test point for the return signal.

- 8) This is the level difference between output 1 and transponder connection pin on the motherboard.
- 9) Typical value at 862 MHz with the maximum gain. The guaranteed worst case value is 1.0 dB worse. Test conditions are described in NOTE 2.
- 10) DIN 45004B, typical value at 862 MHz with maximum gain.
- 11) EN50083-3. Amplifier output was 8 dB cable equivalent sloped. All results are typical values in room temperature, which can be used in system calculations. XMOD is measured at the lowest channel. The CSO performance is 111 dBuV on band 1.
The highest recommended output level for the amplifier is 112.0 dBuV with 42 channels. If amplifier is used with flat output the CSO in band 1 will improve 6.0 dBuV. At other frequencies there are no changes in CSO spec. CTB will decrease 2.5 dBuV. It should be noted that the maximum allowed output level is then 3 dB lower than with sloped output.
- 12) Measured with 77 and 110 NTSC channels. Amplifier output was 12 dB linearly sloped and the used levels were at 55 / 550 / 750 / 862 MHz 35.0 / 42.5 / 45.5 / 47.0 dBmV. All results are typical values in room temperature, which can be used in system calculations. XMOD is measured at 55.25 MHz. The high end of the frequency band up to 862 MHz was fulfilled with QAM channels having a level of -6 dB relative to analogue CW carriers.
The highest recommended output level for the amplifier is 50 dBmV with 110 channels and 52 dBmV with 77 channels.
- 13) Valid over the band 7...65 MHz.
- 14) Active (AC6144)/ passive (AC6140) return module.
- 15) There are plug-in positions at the input and output of the upstream channel. Both positions are using the attenuators of JDA9xx series.
The attenuator at the return input is always selected by default in factory to be JDA900. When the station is working as a node, the equipment is automatically delivered with the plug-in low pass filter of correct frequency.
The wanted output attenuator plug has to be defined in the ordering code.
- 16) The pivot point is at 65 MHz. In 30 MHz operation the control range is 3.5 dB lower. This means that the reached maximum gain in 30 MHz operation is 3.5 dB lower if maximum slope is used
- 17) Valid with active return module AC6144. With plugs AC6140 and AC6147 the spec is 0.3 dB worse.
- 18) The -30 dB level is calculated from the return signal input at output port 1. Output module 1 and return input attenuator were 0 dB plugs. This 2-way connection can be used as an input test point for return signal and test signal injection.
- 19) This is the theoretical level difference between the input connector of the return signal path and the injection pin of the up-stream signal of the transponder. It can be used when adjusting the transmitter of the modem. The input attenuator of the return path is 0 dB.
- 20) Typical values, which can be used in network design. Valid with the active module AC6144.
- 21) With the passive return path. With the active return path and transponder module the values are 5 W higher.

22)

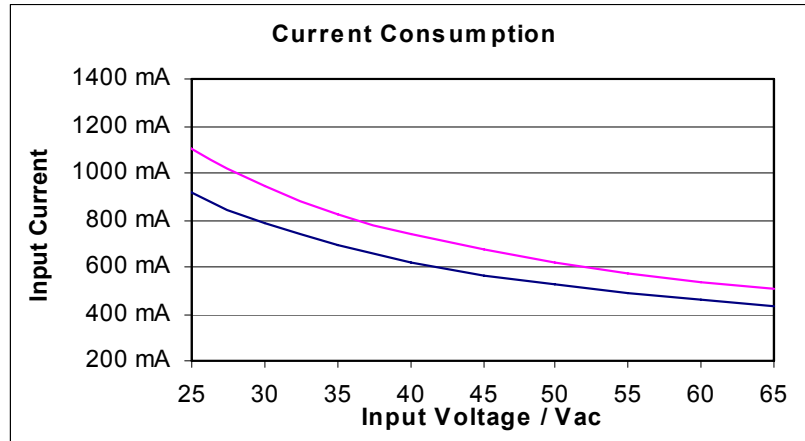

The lower curve is with passive return path. The higher curve is active return path and transponder. Valid for 39 dB amplifier.

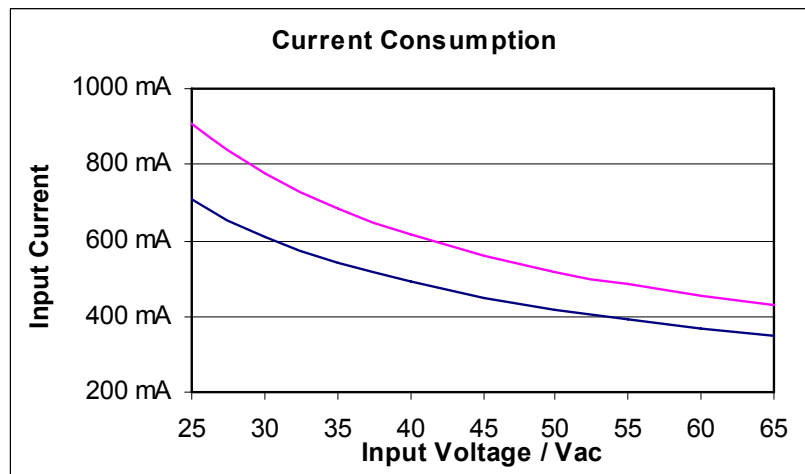

The lower curve is with passive return path. The higher curve is active return path and transponder. Valid for 29 dB amplifier.

- 23) At any frequency from 10 to 862 MHz when the remote current is less than 8 A. The hum modulation is defined to be $20 \lg(2U/U_{pp})$, where 2U is the peak-to-peak value of the carrier and U_{pp} the peak-to-peak value of the modulation signal (50 and 100 Hz). 12 A is the maximum current, which can be locally injected into all ports together. (Simultaneously)
- 24) The housing is tested to be class of IP67. However, in standard delivery conditions the lowest side wall is equipped with a ventilation hole of 1 mm. Then the practical enclosure class is IP54.
- 25) EN61000-4-2, contact discharge to enclosure and RF-ports.
- 26) EN61000-4-5, 1.2 / 50 μ s pulse to RF-ports.
- 27) The typical responsivity of the photodiode is 0.85 A/W at 1310 nm and 0.95 A/W at 1550 nm.
- 28) Dependent on selected receiver module. AC6810 is designed for -7...-2 dBm and AC6820 is for the range -3...+2 dBm.
- 29) This is the maximum output level when OMI is 4.0 % . The level is available with the optical input power of -7 dBm (AC6810) and -3 dBm (AC6820). The used wavelength is 1310 nm.
- 30) Typical value. The guaranteed value is ± 0.9 dB. Flatness is defined with mid-stage equaliser and diplex filter. All other used plug modules are 0 dB jumpers. Spec is valid 2 MHz after the starting frequency of the selected diplex filter.

31) This is a typical value at 862 MHz and the value can be used for C/N calculations.

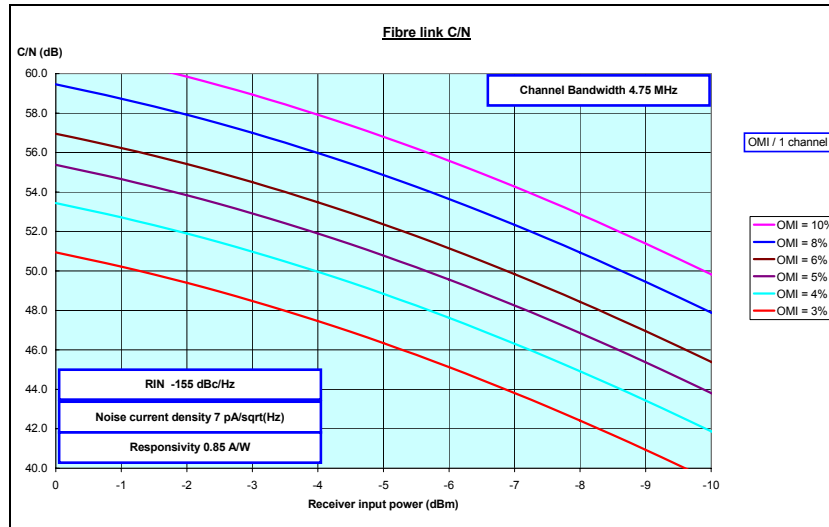

32) Typical input level for 4% OMI. Defined at the output connector of the node. Valid with AC6840 transmitter.

33) An optical receiver (AC6810) and return transmitter (AC6840) are installed.

34)

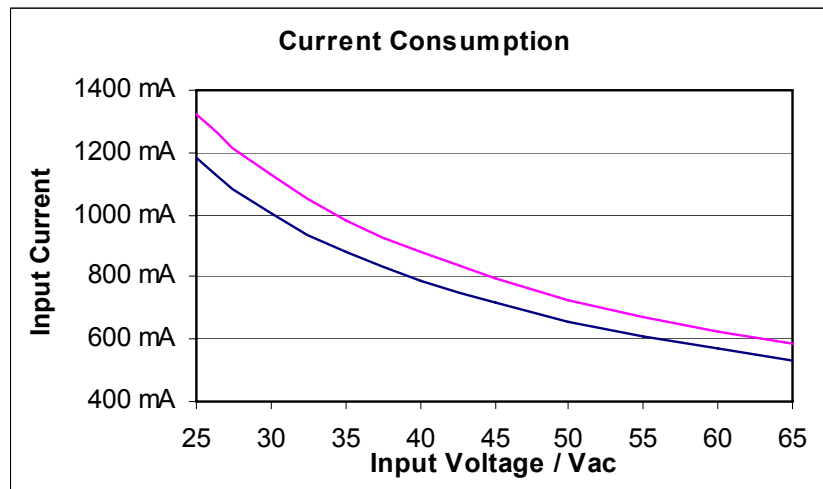

The current need depends on module configuration. The lower curve indicates the 39 dB platform with optics only. The higher one includes also the transponder AC6951.

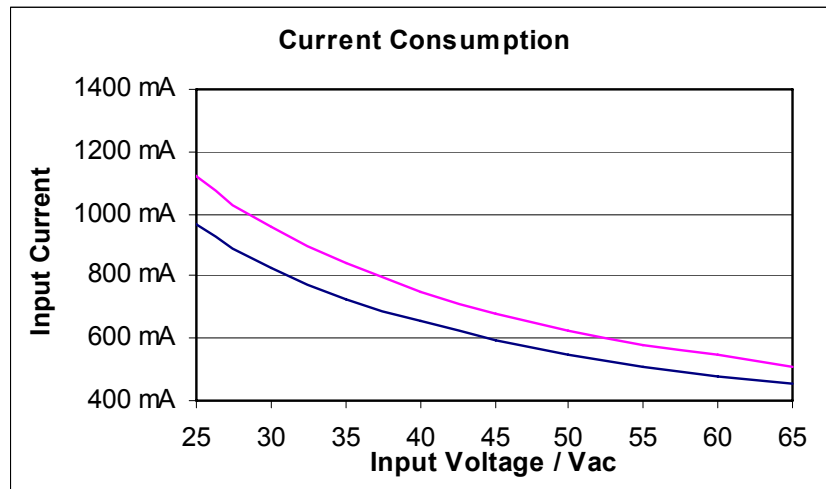

The current need depends on module configuration. The lower curve indicates the 29 dB platform with optics only. The higher one includes also the transponder AC6951.

35) IP classification depends on selected fiber feed through solution

Monitored Functions and Controlled Parameters

- US ingress monitoring
- Return path ingress switch ON/ -6 dB / OFF control
- 65 VAC voltage measurement
- Local DC voltages, 12 V and 24 V
- Temperature measurement
- Gain and slope controlling
- Optical level of the RX module
- Laser current measurement
- Pilot generator control in optical TX
- Individual channel level measurement (AC6951)
- Lid status monitoring
- Local connection indication at server
- Configuration data stored in main board eeprom (station memory)

Block Diagram

Amplifier operation

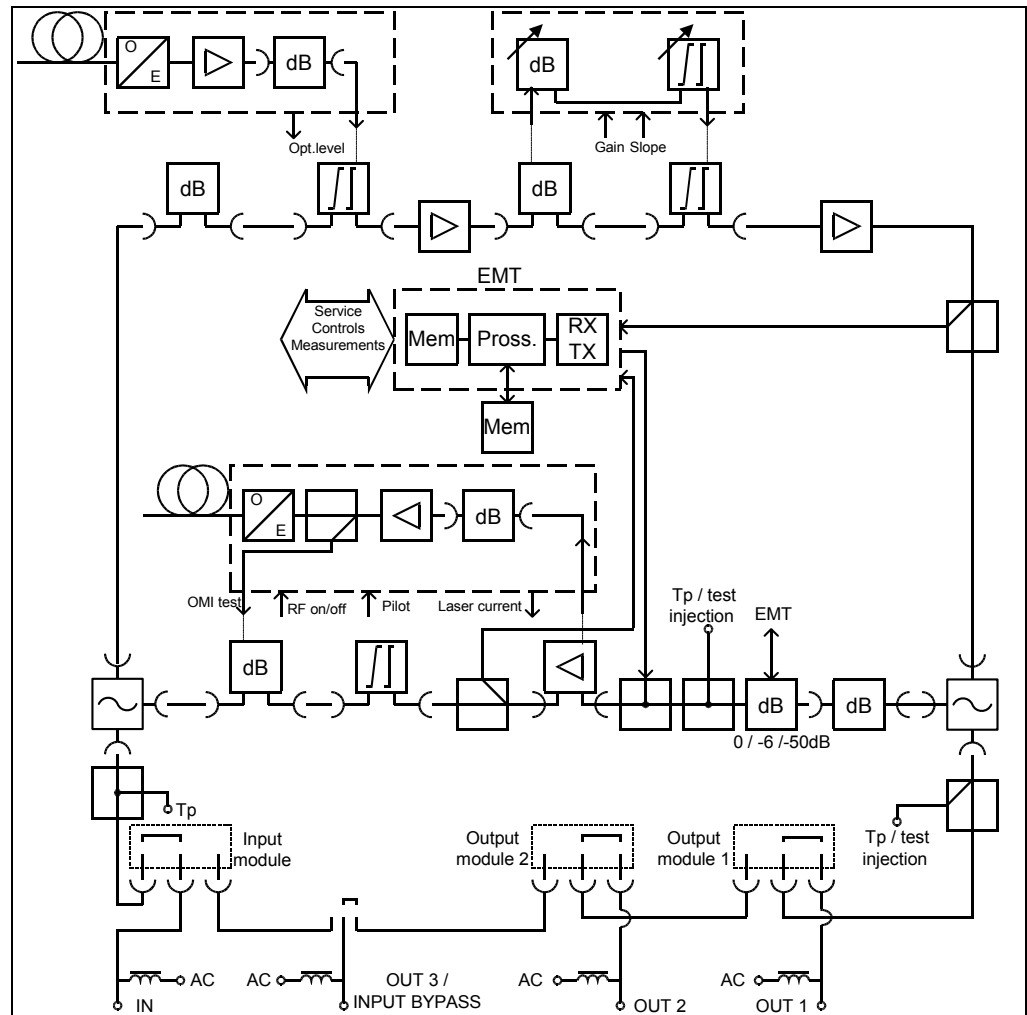

Block Diagram

Optical node operation

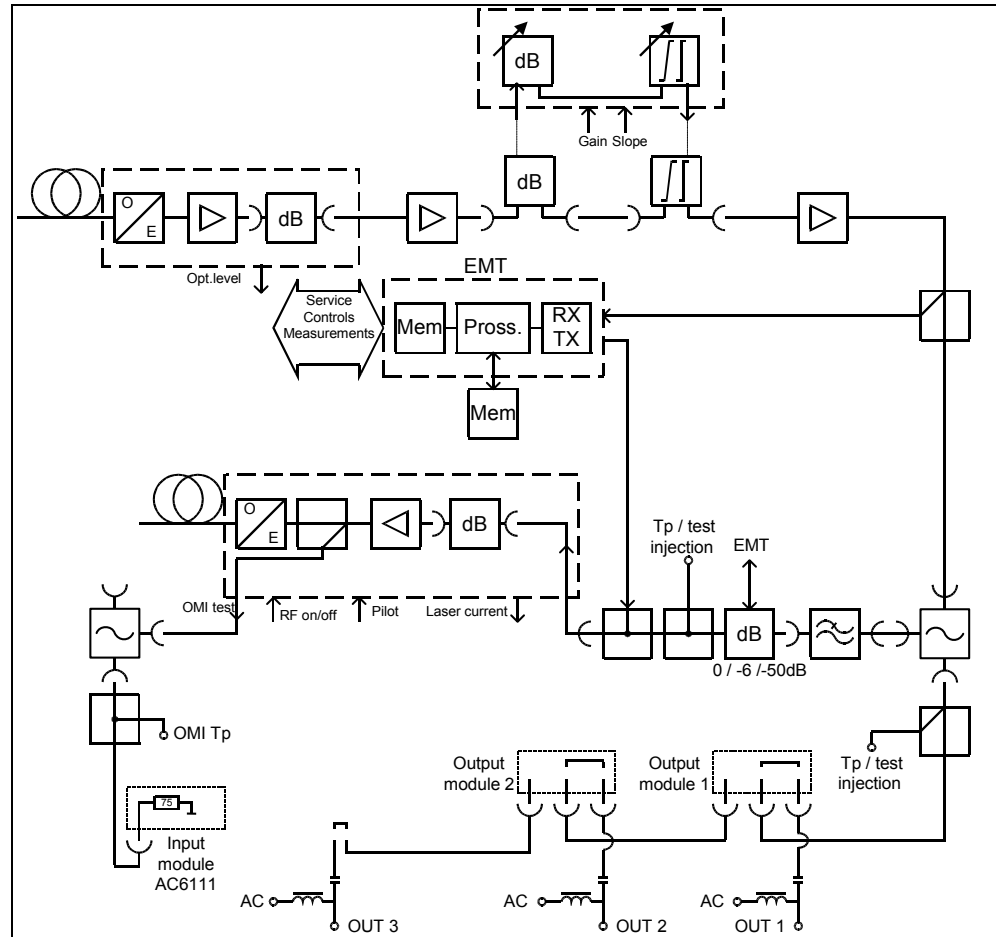

Ordering Information
AC1000 configuration map

	1-	2-	3-	4-	5-	6-	7-	8-	9-
	1 2 3 4	1 2 3	1 3	1 2 3	1 2	1 3	1 2	1	1 2
AC1000									
1-1 Input connection (first from left)	<ul style="list-style-type: none"> A PG11 B 5/8" C IEC D 3.5/12 E F H 1-4 fibres (KDO900) 								
1-2 Input by-pass/output 3 connection	<ul style="list-style-type: none"> A PG11 B 5/8" C IEC D 3.5/12 E F X None (PG11 sealing plug) 								
1-3 Output 2 connection	<ul style="list-style-type: none"> A PG11 B 5/8" C IEC D 3.5/12 E F X None (PG11 sealing plug) 								
1-4 Output 1 connection (first from right)	<ul style="list-style-type: none"> A PG11 B 5/8" C IEC D 3.5/12 E F 								
2-1 Input module	<ul style="list-style-type: none"> A 0 dB, no by-pass (AC6110) B Splitter -3.7 dB, by-pass in use (AC6124) C Tap -8 dB, by-pass in use (AC6128) D Tap -12 dB, by-pass in use (AC6112) E Tap -16 dB, by-pass in use (AC6116) F Tap -20 dB, by-pass in use (AC6119) K Termination plug for OMI test (AC6111) X None 								
2-2 Diplexer filters	<ul style="list-style-type: none"> A 30/47 MHz (2 x CXF030) B 42/54 MHz (2 x CXF042) C 50/70 MHz (2 x CXF050) D 65/85 MHz (2 x CXF065) K Forward path jumper (2 x CXF000) X None 								
2-3 Input attenuator and equaliser	<ul style="list-style-type: none"> A 2 x 0 dB plugs (JDA900 and TXA000) B Manual gain and slope adjustment (AC6171) L Optical receiver X None 								
3-1 Optical receiver RX1	<ul style="list-style-type: none"> 10 RX1 input level -7...-2 dBm (AC6810) 20 RX1 input level -3...+2 dBm (AC6820) XX None 								
3-3 Optical connector for receiver RX1	<ul style="list-style-type: none"> A SC/APC, 9 deg. B FC/APC, 8 deg. C E-2000 D SC/APC, 8 deg. E SC/APC, 8 deg. AMP X None 								
4-1 Interstage slope and gain adjustment	<ul style="list-style-type: none"> A 8 dB slope @ 862 MHz (TDE810) and no gain adjustment plugs B 8 dB slope @ 862 MHz (TDE810) and full gain (JDA900) C 8 dB slope @ 862 MHz, temp. comp. (TTE810) and no gain adjustment plugs D Flat response (TXA000) and full gain (JDA900) K Electrical gain & slope (AC6170) X None 								
4-2 Output module 1	<ul style="list-style-type: none"> A 0 dB, 1 output in use (AC6120) B Splitter -3.7 dB, 2 outputs in use (AC6124) C Tap -8 dB, 2 outputs in use (AC6128) D Tap -12 dB, 2 outputs in use (AC6112) E Tap -16 dB, 2 outputs in use (AC6116) F Tap -20 dB, 2 outputs in use (AC6119) X None 								
4-3 Output module 2	<ul style="list-style-type: none"> A 0 dB, 2 outputs in use (AC6120) B Splitter -3.7 dB, 3 outputs in use (AC6124) C Tap -8 dB, 3 outputs in use (AC6128) D Tap -12 dB, 3 outputs in use (AC6112) E Tap -16 dB, 3 outputs in use (AC6116) F Tap -20 dB, 3 outputs in use (AC6119) X None 								
5-1 Return path input module	<ul style="list-style-type: none"> A 0 dB plug (JDA900) B HPF 15 MHz, ingress blocker (AC6223) F LPF 30 MHz, used with optical TX (AC6210) G LPF 42 MHz, used with optical TX (AC6212) H LPF 50 MHz, used with optical TX (AC6215) I LPF 65 MHz, used with optical TX (AC6217) X None 								
5-2 Return path unit	<ul style="list-style-type: none"> A Active return 21 dB (AC6144) without att. and equal. B Active return 21 dB (AC6144) with 0 dB att. and equal. (2 x JDA900) E Passive return (AC6140) without att. and equal. F Passive return (AC6140) with 0 dB att. and equal. (2 x JDA900) G Active return 30 dB with gain and slope adjustment (AC6146) X None 								
6-1 Return path transmitter TX1	<ul style="list-style-type: none"> 30 FP 1310 nm (AC6830) 40 FP 1310 nm (AC6840) 45 DFB 1310 nm (AC6845) 47 CWDM 1470 nm (AC6847) 49 CWDM 1490 nm (AC6849) 51 CWDM 1510 nm (AC6851) 53 CWDM 1530 nm (AC6853) 55 CWDM 1550 nm (AC6855) 57 CWDM 1570 nm (AC6857) 59 CWDM 1590 nm (AC6859) 61 CWDM 1610 nm (AC6861) XX None 								
6-3 Optical connector for transmitter TX1	<ul style="list-style-type: none"> A SC/APC, 9 deg. B FC/APC, 8 deg. C E-2000 D SC/APC, 8 deg. E SC/APC, 8 deg. AMP X None 								
7-1 Optical filter 1	<ul style="list-style-type: none"> 0 FWDm filter, 1310/1550 nm (AC6570) X None 								
7-2 Optical connectors (3 pcs) for filter 1	<ul style="list-style-type: none"> A SC/APC, 9 deg. B FC/APC, 8 deg. C E-2000 D SC/APC, 8 deg. E SC/APC, 8 deg. AMP X None 								
8-1 Element management transponder	<ul style="list-style-type: none"> A Standard, CATVisor (AC6910) B With tuner level measurement, CATVisor (AC6950) C Standard, HMS (AC6910 HMS) D With tuner level measurement, HMS (AC6950 HMS) G Standard, CATVisor (AC6951) H Standard, HMS (AC6951 HMS), Q2/2007 X None 								
9-1 Power supply	<ul style="list-style-type: none"> A Local powering, euro plug (230 VAC) B Remote powering with cable clamp (65 VAC) C Local powering, UK plug (230 VAC) 								
9-2 Gain and housing	<ul style="list-style-type: none"> A 29 dB platform, painted housing, socket head screws B 39 dB platform, painted housing, socket head screws C 29 dB platform, not painted housing, socket head screws D 39 dB platform, not painted housing, socket head screws 								

DOC0009766, Rev030